

E12295



Connecting cable with socket

ADOAH080VAS0005E08

For 8-pole sockets the core colours are not standardised.
Please note the wiring of the sensor and the sockets (see data sheet).

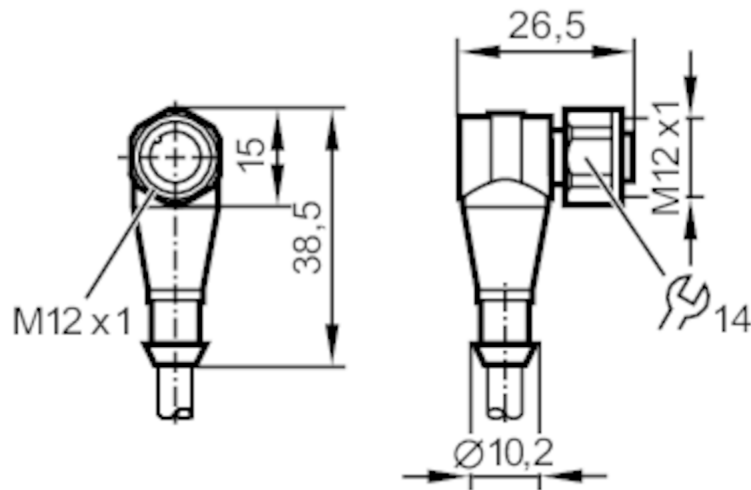

Application	
Special feature	Free from silicone; Gold-plated contacts
Free from silicone	yes
Electrical data	
Operating voltage [V]	< 30 AC / < 36 DC
Max. current load total [A]	2
Operating conditions	
Ambient temperature [°C]	-25...100
Protection	IP 68; IP 69K
Mechanical data	
Weight [g]	325.2
Dimensions [mm]	26.5 x 15 x 38.5
Materials	PVC
Moulded-body material	PVC
Material nut	stainless steel (1.4404 / 316L)
Remarks	
Pack quantity	1 pcs.

E12295



Connecting cable with socket

ADOAH080VAS0005E08

Electrical connection

Cable: 5 m, PVC, orange, \varnothing 6.6 mm; 8 x 0.25 mm² (32 x \varnothing 0.1 mm)

Electrical connection - socket

Connector: 1 x M12, angled; coding: A; Moulded body: PVC; Locking: stainless steel (1.4404 / 316L); Contacts: gold-plated; Tightening torque: 0.7...0.9 Nm

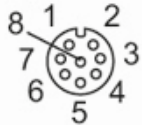

Connection

1	BN
2	WH
3	BU
4	BK
5	GY
6	PK
7	VT
8	OG

colours to DIN EN
60947-5-2

Core colours :

BK =	black
BN =	brown
BU =	blue
GY =	grey
PK =	pink
OG =	orange
VT =	lilac
WH =	white