

EVM035

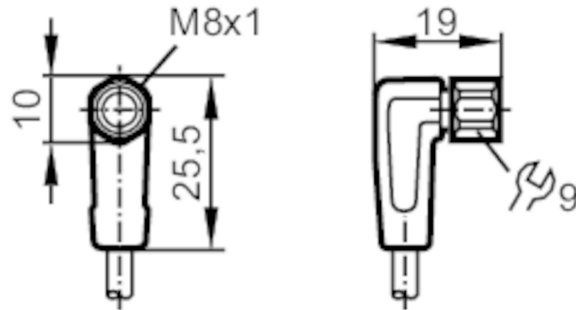

Connecting cable with socket

ADOAF040VAS0015H04



Application		
Special feature	Free from silicone; Halogen-free; Gold-plated contacts; Drag chain suitability	
Free from silicone	yes	
Electrical data		
Operating voltage [V]	< 50 AC / < 60 DC	
Protection class	III	
Max. current load total [A]	3	
Operating conditions		
Ambient temperature [°C]	-25...90	
Note on ambient temperature	cULus: ...80	
Ambient temperature (moving) [°C]	-25...90	
Note on ambient temperature (moving)	cULus: ...80	
Protection	IP 65; IP 67; IP 68; IP 69K	
Tests / approvals		
Vibration resistance	EN 60068-2-6 Fc	20 g (10...3000 Hz) / -20 °C / 50 °C 50 sweep cycles, 1 octave per minute, in 3 axes
Shock resistance	EN 60068-2-27 Ea	100 g 11 ms half sine; 6 shocks each in every direction along the three coordinate axes / -40 °C / 85 °C
Continuous shock resistance	EN 60068-2-29 Eb	40 g 6 ms; 4000 shocks each in every direction of the 3 coordinate axes / -20 °C / 50 °C

EVM035



Connecting cable with socket

ADOAF040VAS0015H04

Fast temperature change	EN 60068-2-14 Na	TA = -40°C; TB = 85°C; t1 = 30 min; t2 = < 10 s 50 cycles
Salt spray test	EN 60068-2-52 Kb	severity level 5 (4 test cycles)

Mechanical data		
Weight	[g]	329.2
Dimensions	[mm]	19 x 10 x 25.5
Materials		housing: TPU orange; Sealing: FKM
Material nut		stainless steel (1.4404 / 316L)
Drag chain suitability		yes
Drag chain suitability	bending radius for flexible use	min. 10 x cable diameter
	travel speed	max. 3.3 m/s for a horizontal travel length of 5 m and max. acceleration of 5 m/s ²
	bending cycles	> 5 Mio.
	torsional strain	± 180 °/m

Remarks	
Pack quantity	1 pcs.

Electrical connection	
Cable: 15 m, PUR, Halogen-free, black, Ø 3.7 mm; 4 x 0.25 mm ² (32 x Ø 0.1 mm)	

Electrical connection - socket	
Connector: 1 x M8, angled; coding: A; Locking: stainless steel (1.4404 / 316L); Contacts: gold-plated; Tightening torque: 0.3...0.5 Nm	

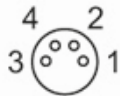

Connection

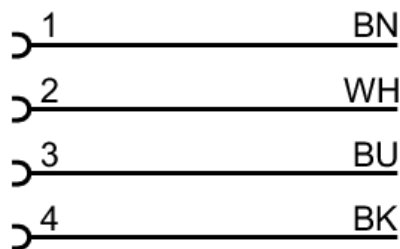

	Core colours :
BK =	black
BN =	brown
BU =	blue
WH =	white