

E10749

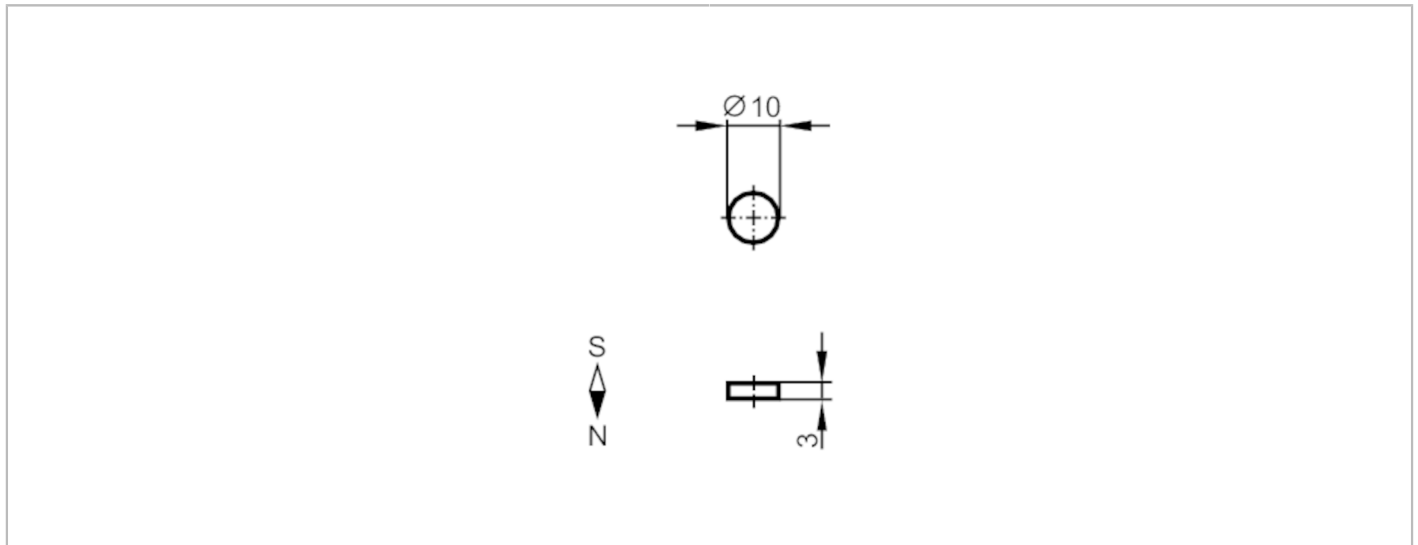

Damping magnet

MAGNET M1.0 SAMARIUM COBALT



Operating conditions		
Ambient temperature	[°C]	-50...350
Mechanical data		
Weight	[g]	0.7
Dimensions	[mm]	Ø 10 / L = 3
Materials		Samarium cobalt
Magnetic field strength	[mT]	200
Remarks		
Pack quantity		1 pcs.