

E43210

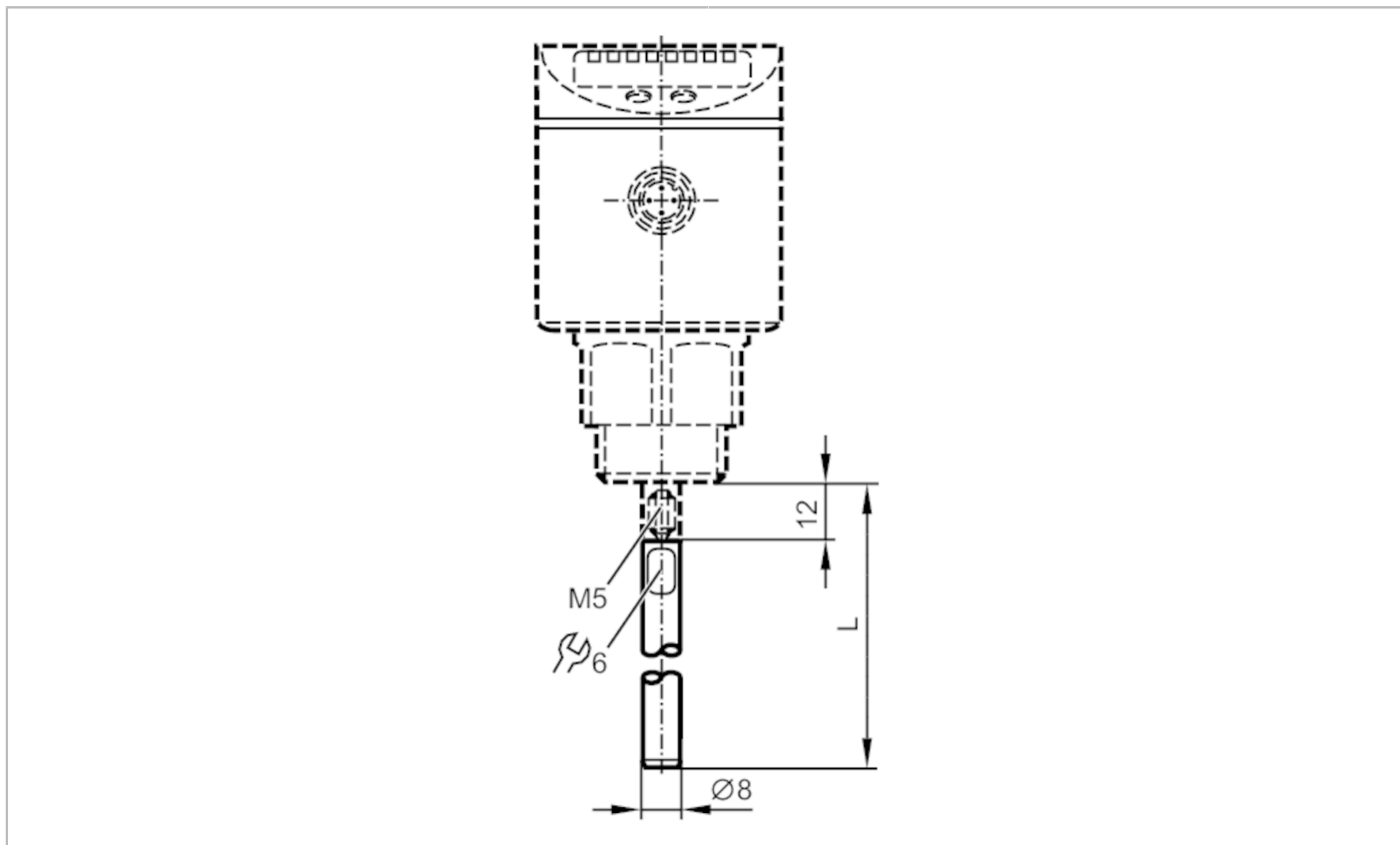

Probe for level sensors

LR PROBE L1600



Application

Design for level sensors LR

Measuring/setting range

Probe length L [mm] 1600

Mechanical data

Weight [g] 695

Materials stainless steel (1.4404 / 316L)

Tightening torque [Nm] 4

Remarks

Pack quantity 1 pcs.