

EVF523

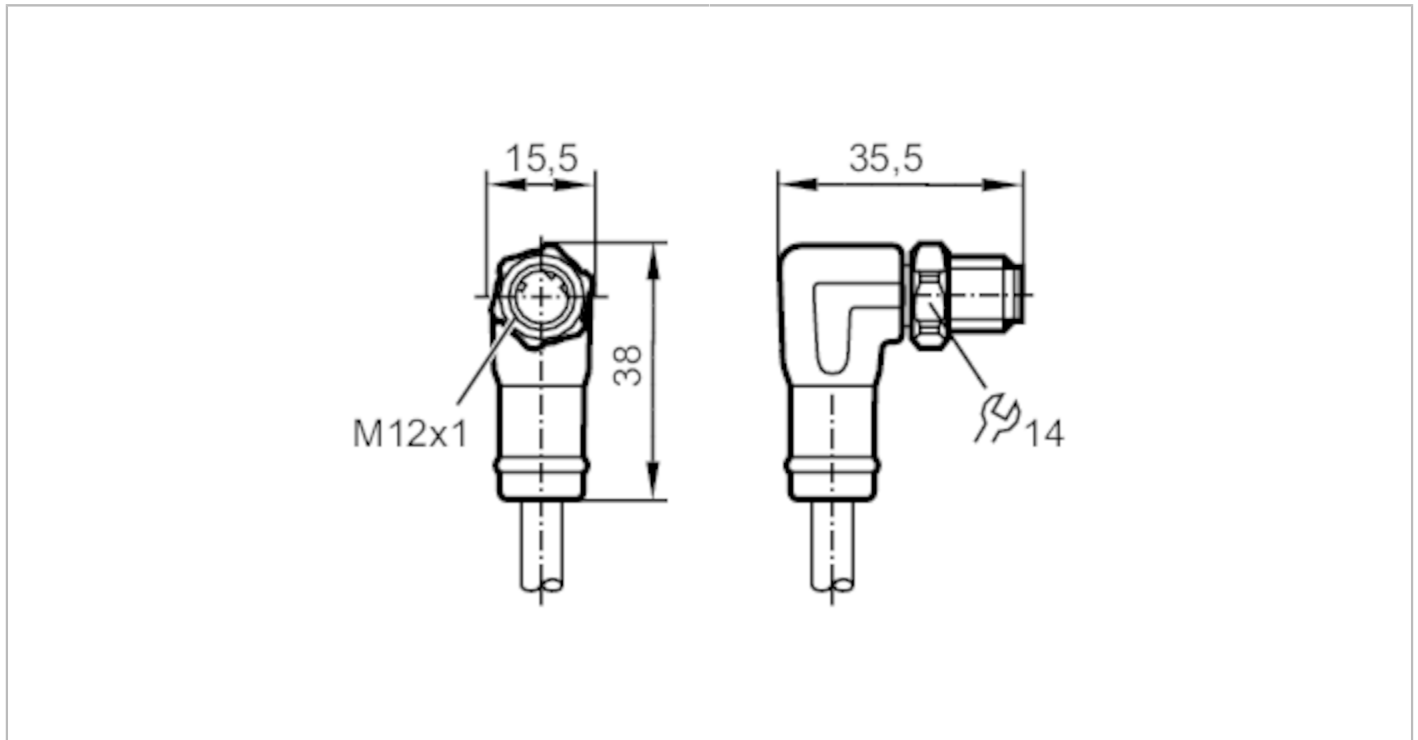

Connecting cable with plug

ASTAN040VAS0002P04



Application	
Special feature	Free from silicone; Halogen-free; Gold-plated contacts; Screened cable; Drag chain suitability
Design	Ethernet cable, D-coded
Application	Industrial Ethernet; CAT5/CAT5e; 100 Mbit/s; hygienic and wet areas in the food industry
Free from silicone	yes
Electrical data	
Operating voltage [V]	30 AC / 60 DC
Protection class	III
Max. current load total [A]	4
Operating conditions	
Ambient temperature [°C]	-25...100
Ambient temperature (moving) [°C]	0...80
Protection	IP 65; IP 67; IP 68; IP 69K
Mechanical data	
Weight [g]	146.8
Dimensions [mm]	38 x 15.5 x 35.5
Materials	PP Halogen-free
Moulded-body material	PP
Material nut	stainless steel (1.4404 / 316L)
Drag chain suitability	yes

EVF523



Connecting cable with plug

ASTAN040VAS0002P04

Drag chain suitability	bending radius for flexible use	min. 15 x cable diameter
	travel speed	max. 3.3 m/s for a horizontal travel length of 5 m and max. acceleration of 5 m/s ²
	bending cycles	> 1 Mio.
	torsional strain	± 180 °/m

Remarks

Pack quantity	1 pcs.
---------------	--------

Electrical connection

Cable: 2 m, MPPE, Halogen-free, grey, Ø 6.5 mm, shielded; PROFINET Type C; 4 x 0.34 mm² (7 x Ø 0.25 mm)

Electrical connection - plug

Connector: 1 x M12, angled; coding: D; Moulded body: PP; Locking: stainless steel (1.4404 / 316L); Contacts: gold-plated; Tightening torque: 0.6...1.2 Nm; Shielded connection cable: screen connected



Connection

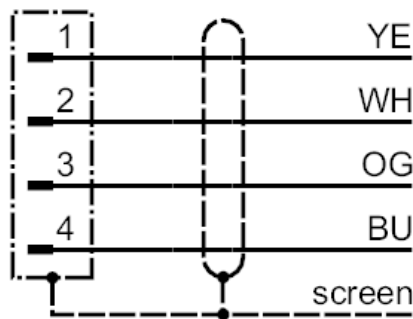

Core colours :
 BU = blue
 OG = orange
 WH = white
 YE = yellow